

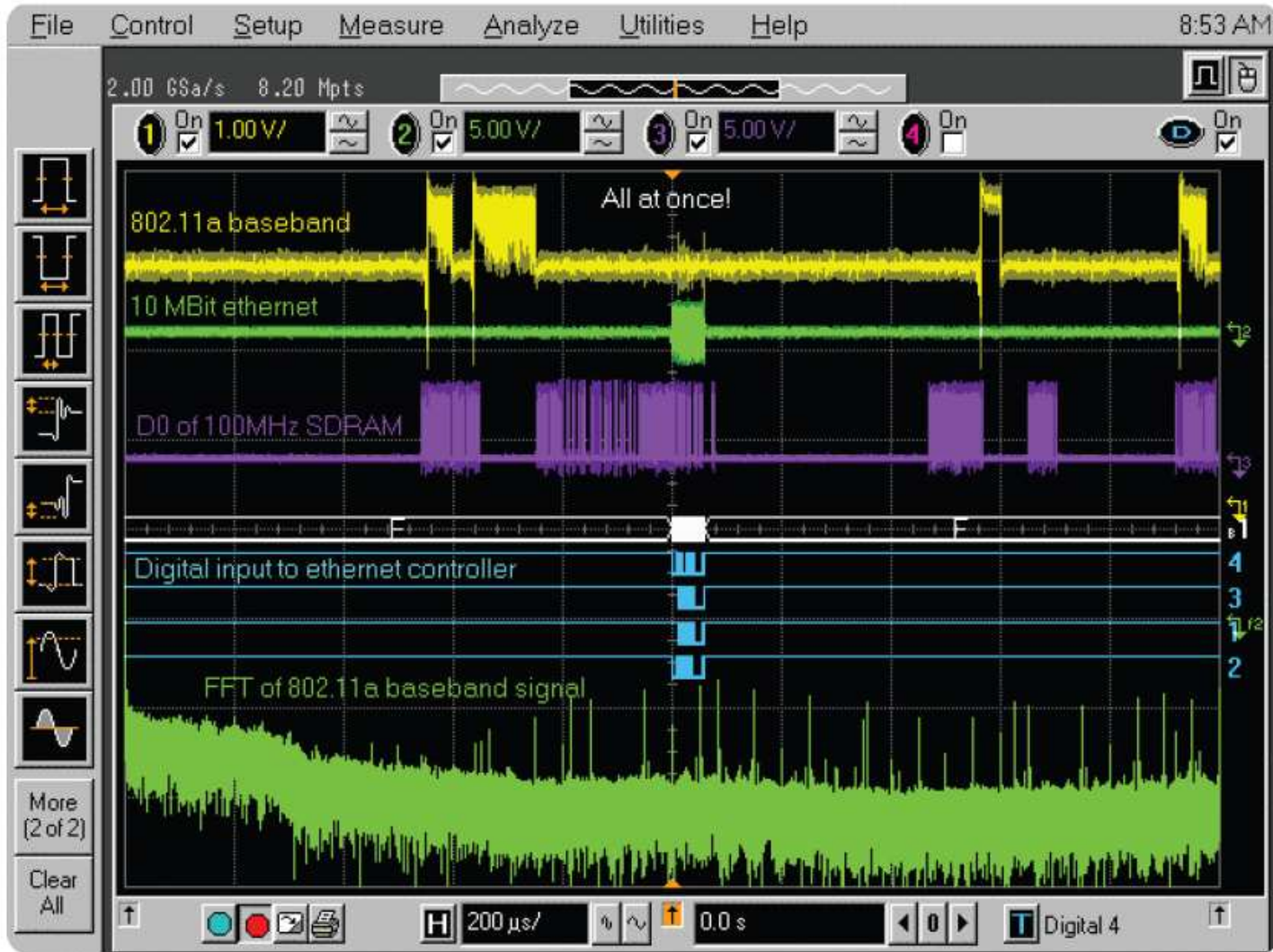

# Digital Oscilloscope

# EIM Chap 3 – Digital oscilloscope



## ■ Introduction

- A graph-displaying device of electrical signal
  - X axis: Time (sometime: voltage )
  - Y axis: Voltage
  - Z axis: Intensity or brightness;
- Information given by digital oscilloscopes
  - Time and voltage
  - Frequency and phase
  - DC and AC components
  - Spectral analysis
  - Rise and fall time
  - Mathematical analysis

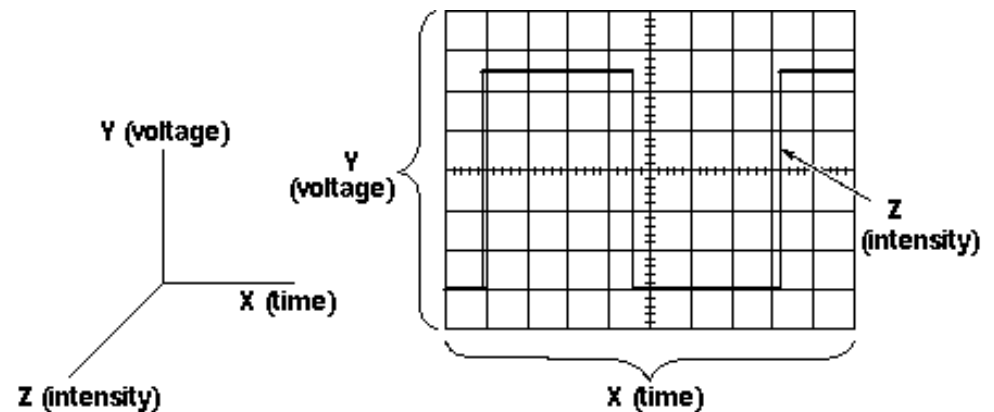

■ Introduction

- Control panel of an oscilloscope
  - Vertical Section
  - Horizontal Section
  - Trigger Section

■ Basic setting

- Vertical system
  - attenuation or amplification of signal (volts/div), signal coupling, etc.
- Horizontal system
  - The time base (sec/div),
- Trigger system
  - To stabilize image for a repeating signal and to trigger on a single event

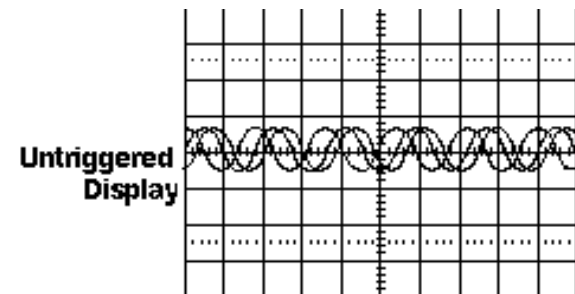
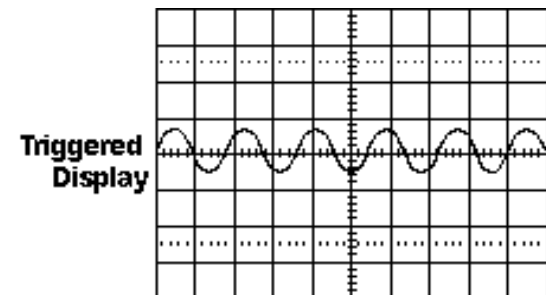

■ Types of oscilloscopes

- ❑ **Analogue oscilloscope** - the traditional form of oscilloscope that relies on analogue techniques. It takes signals, amplifying them in an analogue format and displaying them on a cathode ray tube;
- ❑ **Digital storage oscilloscope (DSO)** - the conventional form of digital oscilloscope. It uses a raster type screen to displays the waveform image and other elements (text, cursors, etc);
- ❑ **Digital phosphor oscilloscope (DPO):** - a highly versatile form of oscilloscope that uses a parallel processing architecture and dedicated processor for waveform acquisition that enable it to capture and display short signals (spurious pulses, glitches and transition errors). It can display the signal in three dimensions: time, amplitude and the values distribution over time (all in real time);
- ❑ **Sampling oscilloscope** - is used for analyzing very high frequency repetitive signals (higher than the sample rate). It builds up a picture of the waveform with the collected samples from several successive waveforms and assembling them correctly. It use so called *equivalent-time sampling technique* This oscilloscope bandwidth sometimes can be as high as 50 GHz.

■ Types of oscilloscopes (cont'd)

□ Analog

Real-time display of signals  
Block diagram : Sweep generator and vertical amplifier

Analog Display

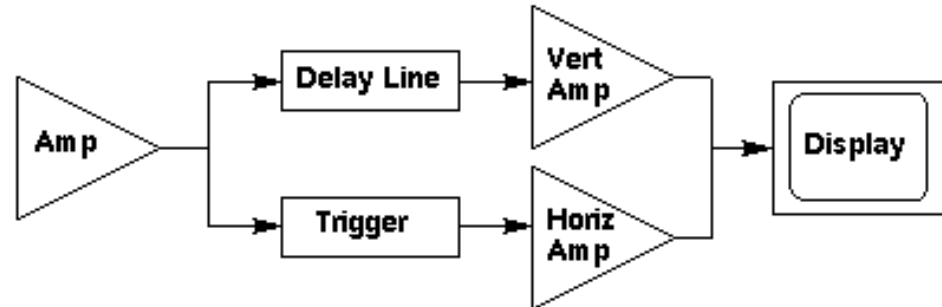

Serial Processing



□ Digital oscilloscope

- Serial processing
- Parallel processing

Parallel Processing

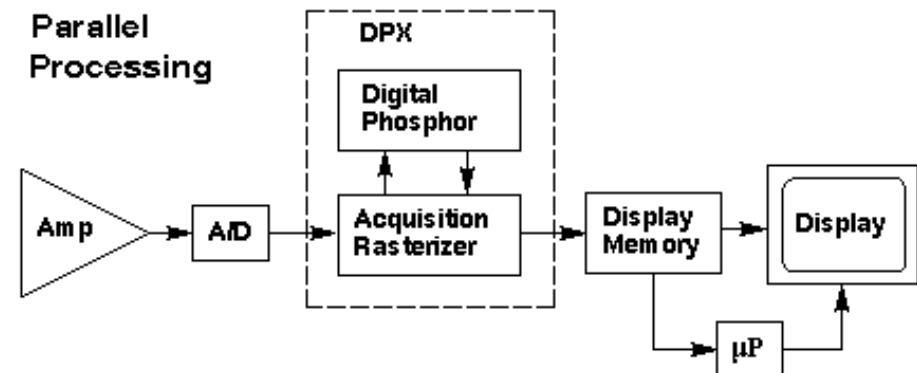

## EIM Chap 3 – Digital oscilloscope

### ■ Types of oscilloscopes (cont'd)

**DSO**

versus

**DPO**

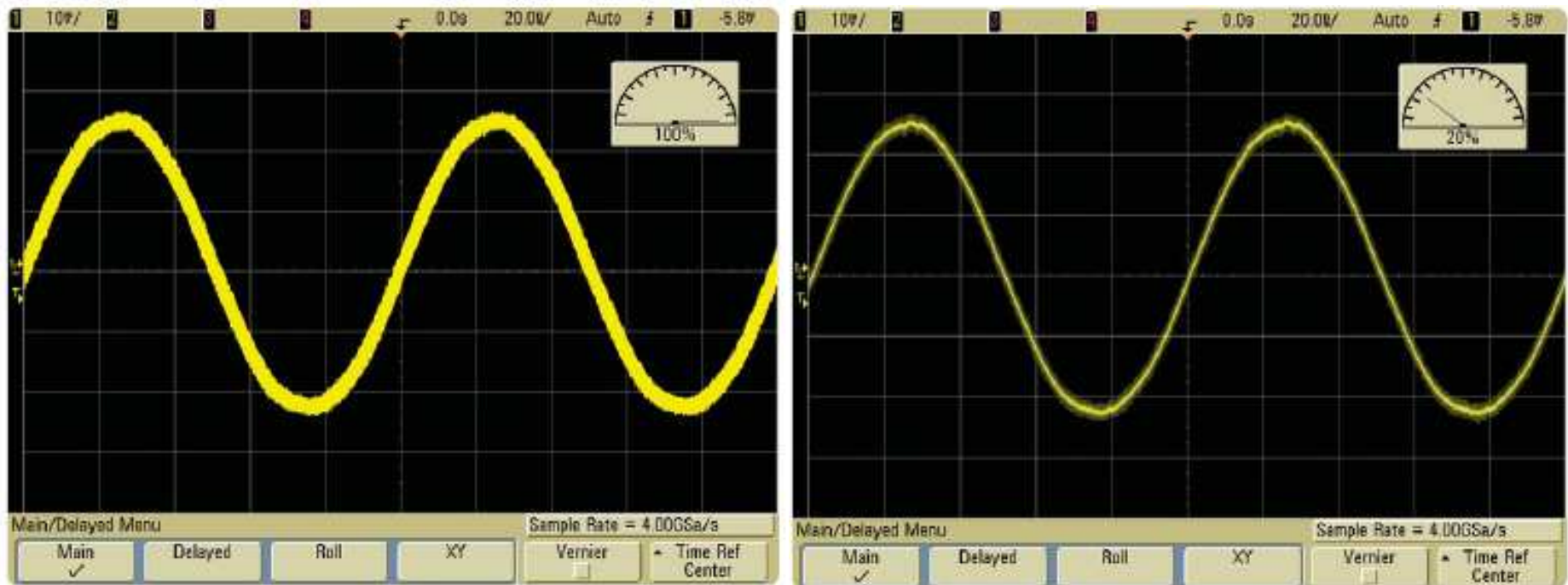

Constant intensity for DSO, proportional with appearance frequency for DPO

## EIM Chap 3 – Digital oscilloscope

### ■ DSO

	RIGOL	Tek
	DS1204B	TDS2024B
Bandwidth	200 MHz	200 MHz
Real-time Sample Rate	2 GSa/s	2 GSa/s
Equivalent Sample Rate	50 GSa/s	×
Memory Depth	8 k	2.5 k
Trigger Modes	Edge, Pulse Width, Pattern/TV	Edge, Pulse Width, Video,
Display	QVGA (320 x240), 65,000 colors, 5.7" TFT LCD	1/4 VGA passive color LCD
Screen Display	12 div	10 div
Standard Interface	USB Device, USB Host×2, LAN	USB Device, USB Host
Automatic Measurement	22 (display 18 measure data)	11 (display 5 measure data)
Internal Storage	10 waveforms/10 setups	4 waveforms/10 setups
USB Storage	8 bit Bitmap, 24 bit Bitmap, PNG, CSV, Waveform, Setup	CSV, Setup
Pass/Fail Detection	√	×
Waveform recorder/replay	√	×
Adjustable trigger sensitivity	√	×

Full-scale (FS) input range ( $V_{pk-pk}$ ) = 0.2 V, 0.4 V, 1 V, 2 V, or 5 V

Example of DSO technical specification



■ **DSO** - main functional blocks

- ❑ Signal conditioning
- ❑ Acquisition block
- ❑ Trigger block
- ❑ Base time
- ❑ Microprocessor
- ❑ Display
- ❑ Power supply
- ❑ Front panel
- ❑ Communication

Interfaces (USB, GPIB  
RS232, etc.)

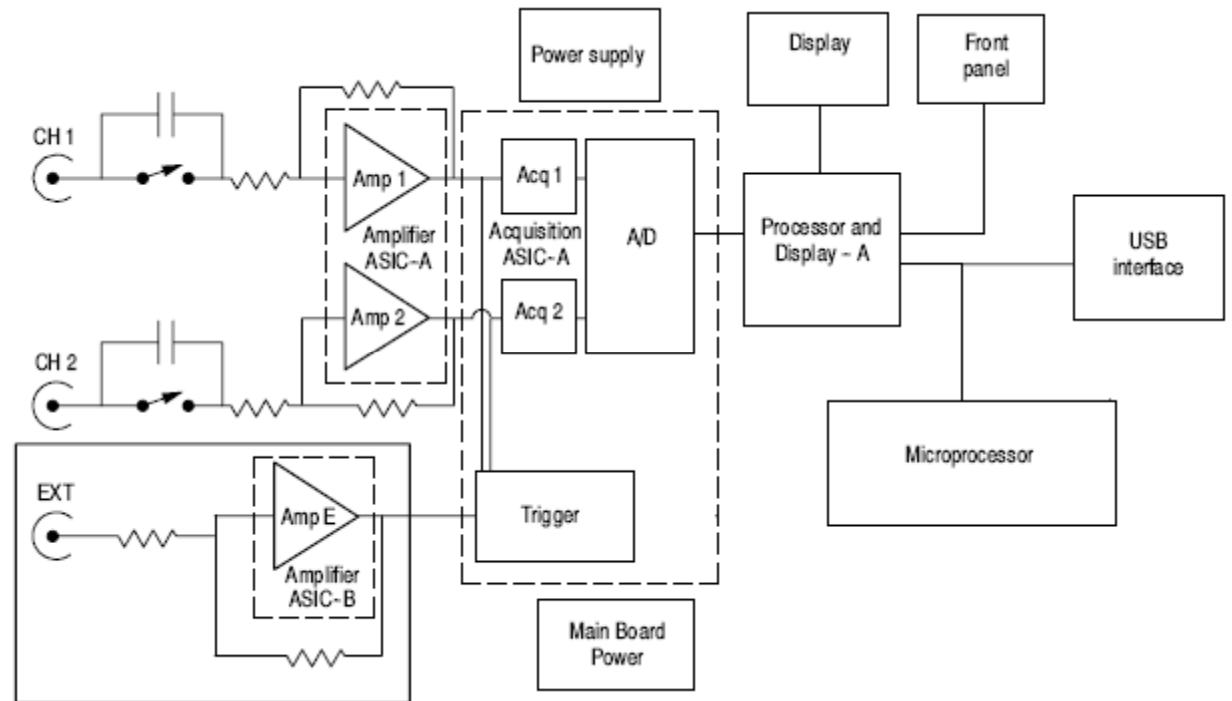

Dual channel DSO – block scheme

## EIM Chap 3 – Digital oscilloscope

- Signal conditioning (similar with analog scope)
  - ❑ Signal coupling (AC, DC , GND)
  - ❑ Adding or removing continuous component
  - ❑ Filtering, amplification
  - ❑ Attenuation with compensation
- Trigger block
  - ❑ Operation realized in analog domain
  - ❑ Generate *syncro pulses* (SY)
  - ❑ Has the same adjustments as analog scope: trigger source, trigger level, slope, hold off timer, signal coupling (AC, DC), trigger signal filtering (direct, LPF, HPF, noise reduction )

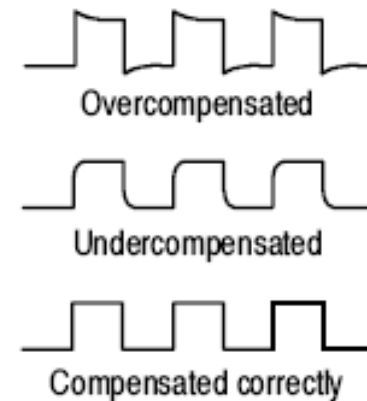

## EIM Chap 3 – Digital oscilloscope

- Acquisition block (real-time sampling)
  - Uniform sampling the signal (fixed rate  $T_s$ )
  - Signal quantization - fast ADC (usually 8 bits)
  - Each acquisition cycle (AC) identified by SY command
  - Samplers of acquisition cycle store in memory
  - Acquisition time greater than display time ( $T_a > T_d$ )
  - Acquisition data: pretrigger / posttrigger
  - Acquisition type:
    - Normal (sample);
    - Peak detect;
    - Average;

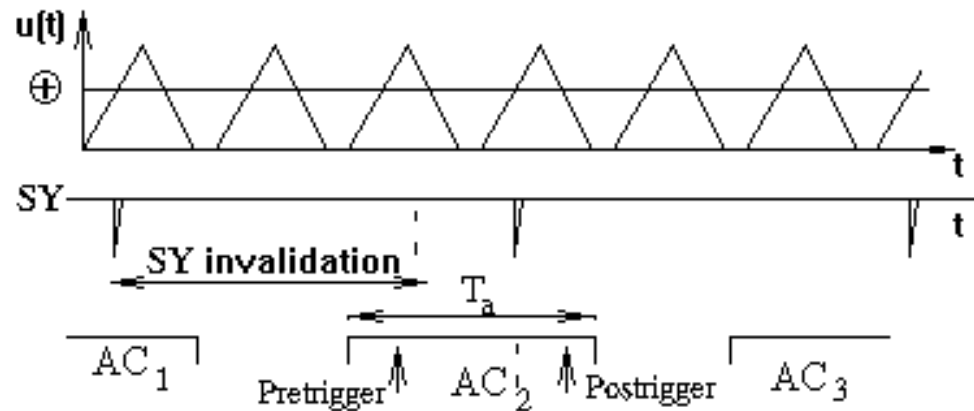

## EIM Chap 3 – Digital oscilloscope

- Acquisition and display mode:
  - Pre-trigger mode;
  - “Normal” mode;
  - Delay mode;

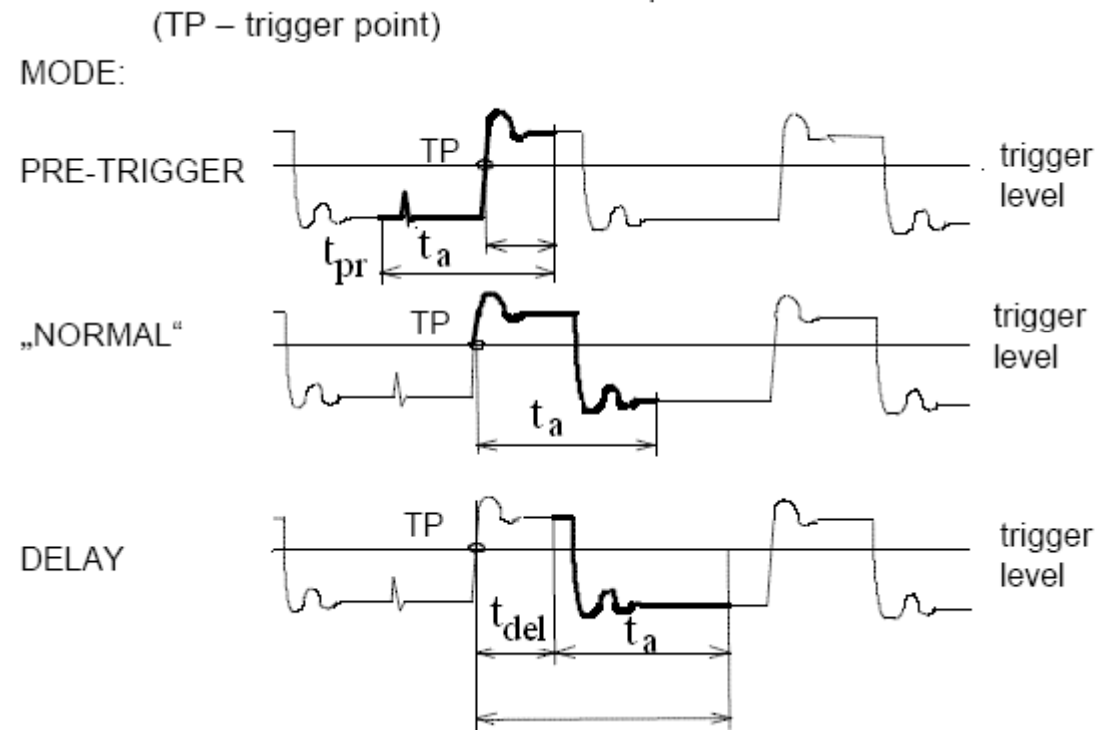

### ■ Sampling mode

#### □ Real-time sampling

- 4 to 10 samples per period of the highest-frequency component;
- allows pre-trigger mode;
- allows capturing transients;

#### □ Sequential sampling in equivalent time

- for periodic signals only;
- in each period one sample only shifted by  $\Delta t$  ;
- equivalent sampling frequency  $f_{S.EQ} = 1 / \Delta t$  ;

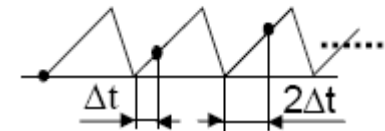

#### □ Random sampling in equivalent time

- for periodic signals only;
- sampling permanently with maximum sampling frequency (several samples during period of highest-frequency component);
- each set of samples delayed by random but known time;
- faster reconstruction than sequential sampling;

## EIM Chap 3 – Digital oscilloscope

### ■ Sample acquisition

- Display divided in pixels (exp:  $N_r \times N_c = 240 \times 250$ );
- Acquiring one sample per display column;
- Sampling rate function of horizontal scale

$$f_s = \frac{N_c}{T_d} = \frac{N_c}{N_x C_x}$$

$N_c$  - number of display columns

$N_x$  - number of horizontal divisions

- Maximum sampling rate is technological limited ( $f_{Smax}$ )
  - does not acquire rapid variations in the signal for full waveform display;
  - may cause narrow pulses to be missed;

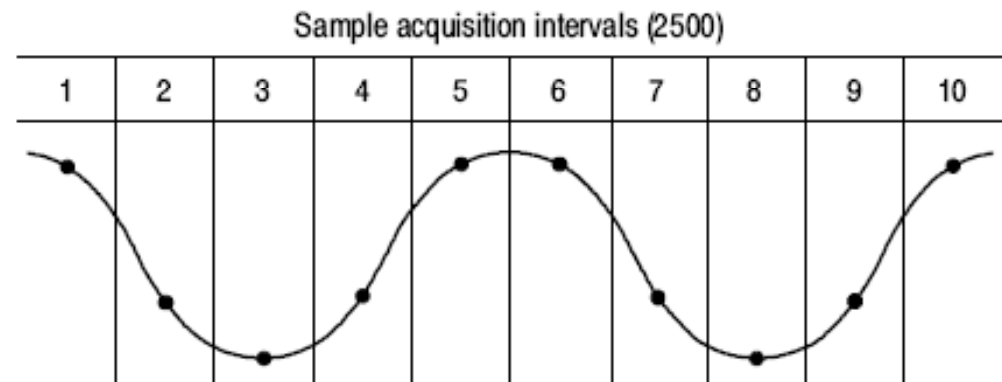

● Sample points

Sample mode acquires a single sample point in each interval.

■ Sample acquisition

- For base time adjustment  $C_x < C_{x\ min}$ , the sampling rate is limited by  $f_{S\ max}$  and there are insufficient samplers number ( $N_A < N_C$ )

- Interpolation

  - Linear interpolation;

(for relative many samplers)

$$f_S \gg 2 \cdot f_m$$

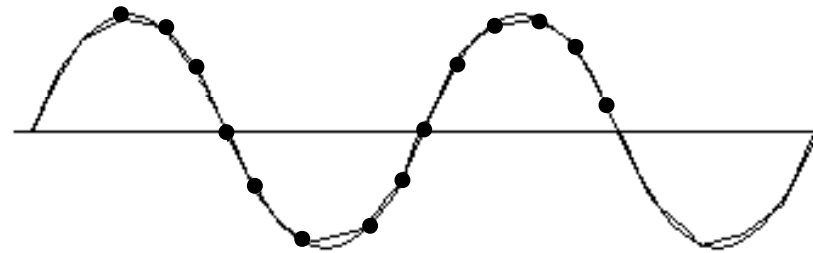



  - Band-limited interpolation (sinc);

$$f_S > 2 \cdot f_m$$

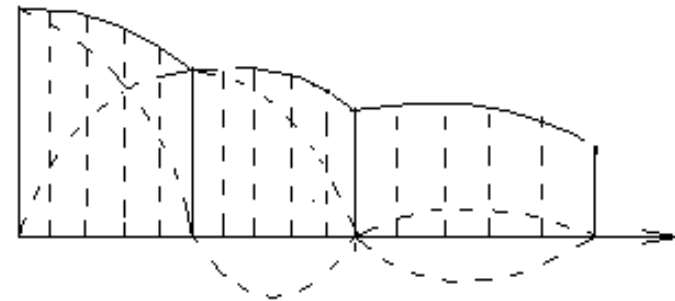

## EIM Chap 3 – Digital oscilloscope

### ■ Band-limited interpolation (sinc);

- Having samplers  $x(nT_s)=x(nNT_{px})$  ,  $n=\{\dots, -2, -1, 0, 1, 2 \dots\}$  the oscilloscope must compute  $x(mT_{px})$ ,  $m=\{\dots, -2, -1, 0, 1, 2 \dots\}$

- Assuming  $x(t)$  band-limited signal:  $X(\omega)=0, |\omega|>\omega_M$  ,  $\omega_M < \Omega_s/2$

- Sampled signal spectrum: 
$$X_e(\omega) = \frac{1}{T_s} \sum_{n=-\infty}^{\infty} X(\omega - n\Omega_s), \quad T_s = \frac{2\pi}{\Omega_s}$$

- Recovered signal spectrum: 
$$X(\omega) = T_s \cdot X_e(\omega) \quad \text{for} \quad \omega \in \left(-\frac{1}{2}\Omega_s, \frac{1}{2}\Omega_s\right)$$

- Recovered signal in time domain: 
$$x(t) = \sum_{n=-\infty}^{\infty} x(nT_s) \cdot \text{sinc} \omega_t(t - nT_s) \quad , \quad \omega_t = \frac{1}{2}\Omega_s = \pi f_s$$
  
(ideal LPF filtering with  $f_{-3dB} = f_s/2$ )

- Displayed re-sampled signal:

$$x(mT_{px}) = \sum_{n=-\infty}^{\infty} x(nT_s) \cdot \text{sinc} \omega_t(m - nN)T_{px} = \sum_{n=-\infty}^{\infty} x(nNT_{px}) \cdot \text{sinc} \omega_t(m - nN)T_{px}$$

$$\text{for } m=nN \rightarrow x(mT_{px})=x(nT_s)$$

- $2f_m > f_s$  result in aliasing spectrum and signal distortion;



## EIM Chap 3 – Digital oscilloscope

- Band-limited v.s. linear interpolation ( $C_x < C_{x \min}$ )

Assuming the same sample rate and displayed points number

- for  $f_s \gg 2 \cdot f_m$  → identically displayed waveforms;
- for  $f_s > 2 \cdot f_m$ , but few samples per signal period ( $< 10$ ) → different displayed waveforms: more accurate for band-limited interpolation;

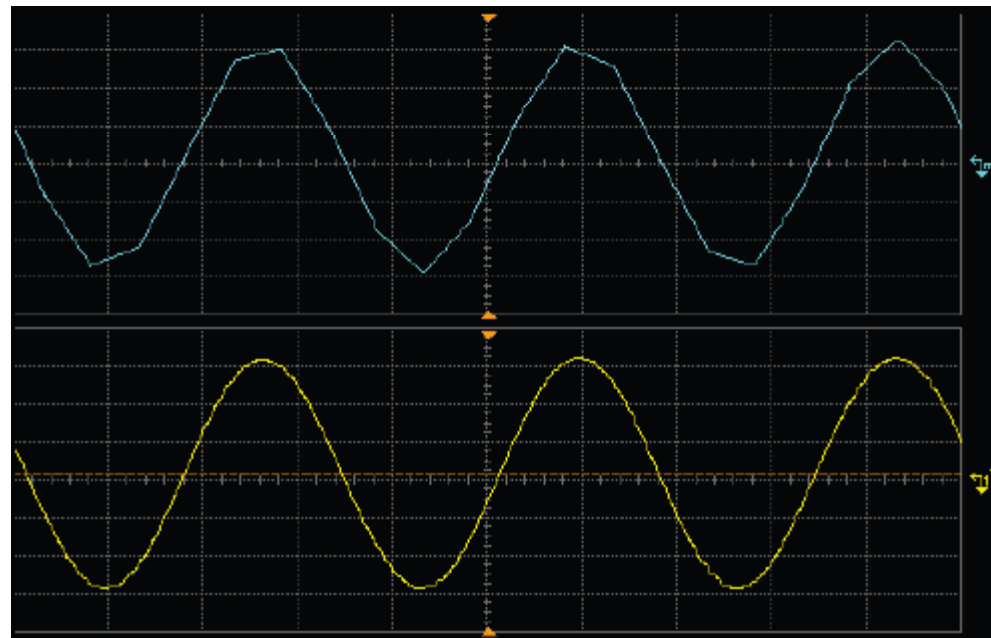

## EIM Chap 3 – Digital oscilloscope

### ■ Aliasing phenomena – time domain

(linear or band-limited interpolation and  $2f_m > f_s$ );

- Displayed signal has lower frequency than real input signal;

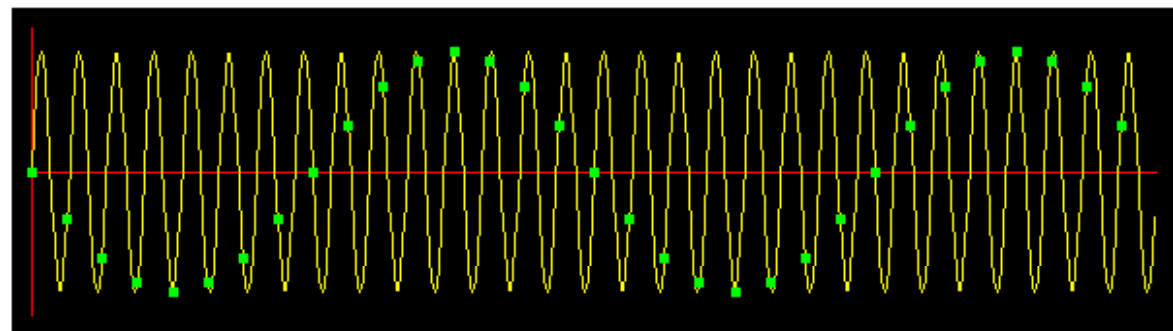

Input frequency: 7500 Hz Plot  Input signal  Grid  Sample points  Alias frequency

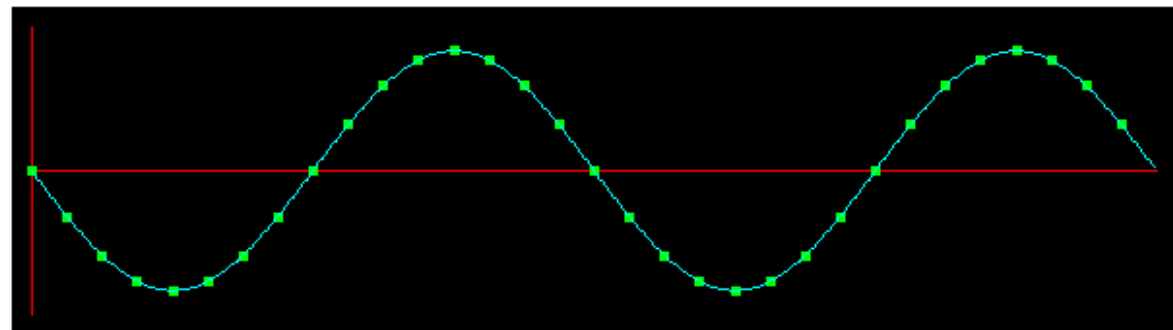

Input frequency: 7500 Hz Plot  Input signal  Grid  Sample points  Alias frequency

## EIM Chap 3 – Digital oscilloscope

### ■ Aliasing phenomena – frequency domain

(band-limited interpolation and  $2f_m > f_S$  )

- Higher frequency components of signal are displayed on lower frequency;
- Correct displayed components are on the frequency  $< f_S / 2$ ;

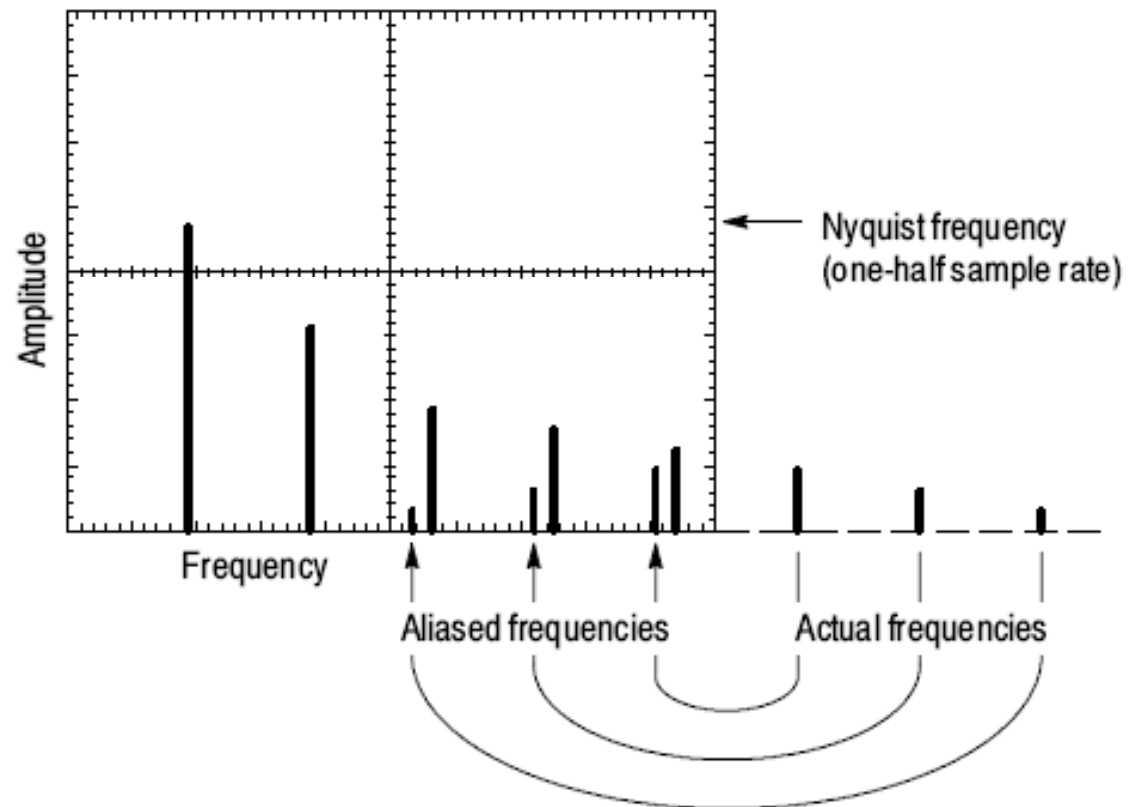

## EIM Chap 3 – Digital oscilloscope

### ■ Peak detection

- the oscilloscope finds the highest and lowest values of the input signal over each sample interval;
- Sampling at maximum rate;
- the oscilloscope can acquire and display narrow pulses;
- the oscilloscope can identifier aliasing situation
- Noise will appear

to be higher;

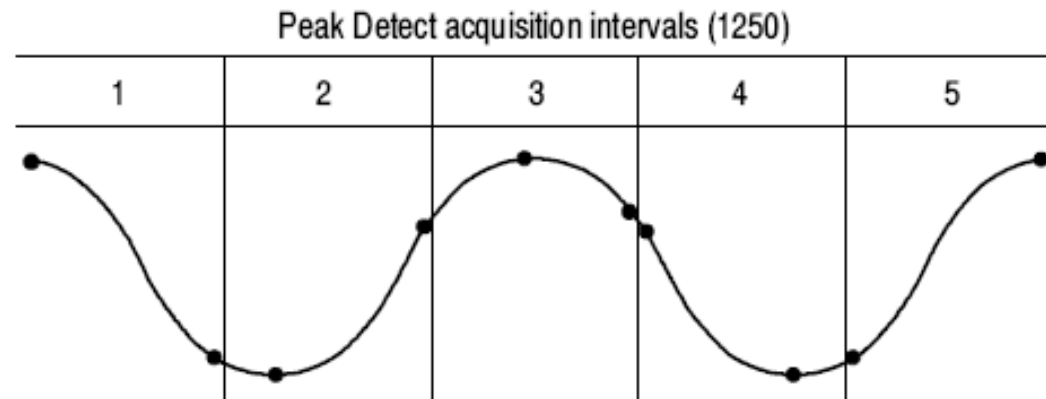

● Sample points displayed

Peak Detect mode displays the highest and lowest acquired voltage in each interval.

## EIM Chap 3 – Digital oscilloscope

### ■ Peak detection (cont'd)



Noise augmentation

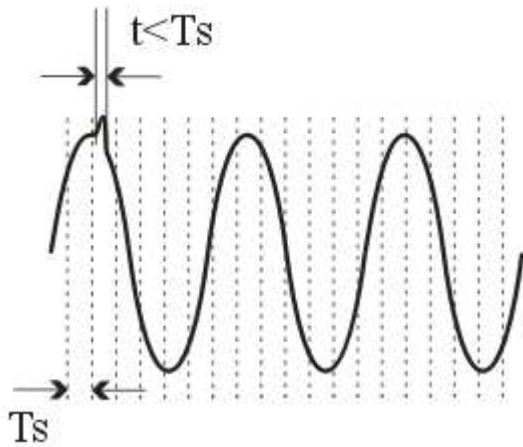

Small pulse display

### Aliasing detection

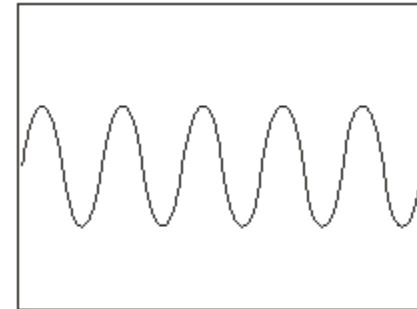

Sample mode



Peak detect mode

■ Average

- ❑ Fixed windows
- ❑ Mobile window
- ❑ Continuous

- reduces asynchronous noise level

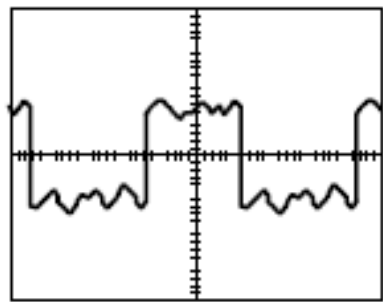

Sample

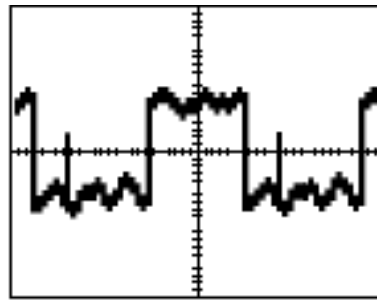

Peak Detect

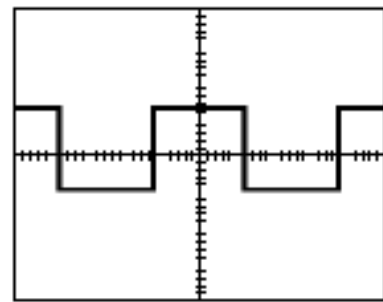

Average

Comparative signal displayed in time domain

## EIM Chap 3 – Digital oscilloscope

- Fixed windows average of length  $M$ 
  - $M$  acquisition cycles
  - Needs high memory
  - Introduces high delay ( $M \cdot k \cdot T_S$ )

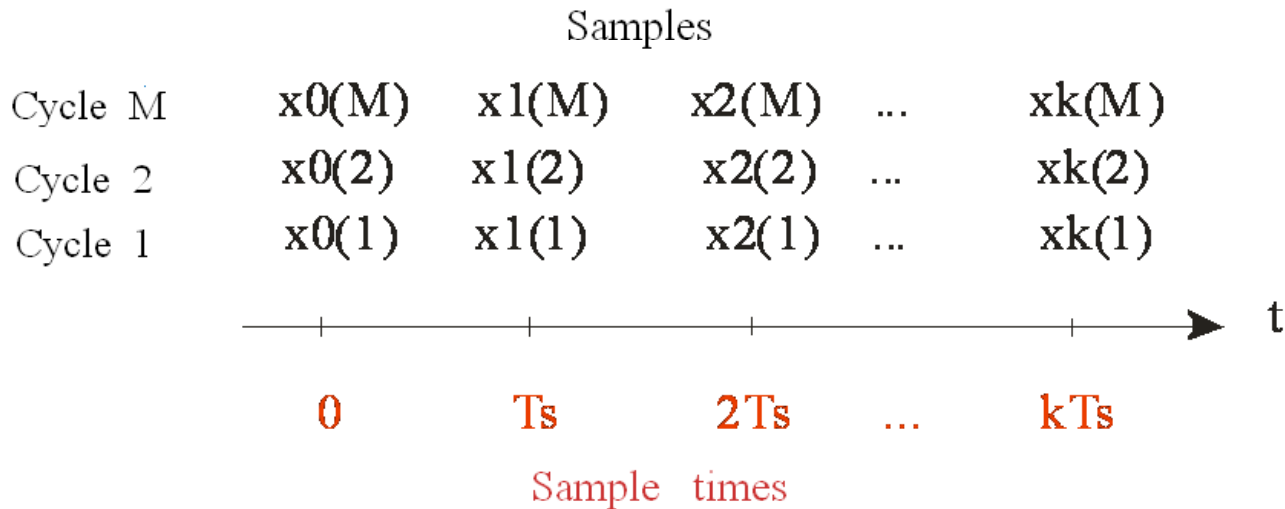

## EIM Chap 3 – Digital oscilloscope

- Fixed windows average of length  $M$ 
  - Displayed signal values have improved SNR

-  $x_{disp}[k]$  - displayed signal samples mean value, in pixel  $k$  :  $x_{disp}[k] = \frac{1}{M} \sum_{i=1}^M x_i[k]$

-  $x_i[k]$  - signal sample in cycle  $i$  for pixel  $k$  (noise impressed):  $x_i[k] = u_i[k] + n_i[k]$

-  $u_i[k]$  - ideal signal sample in cycle  $i$ , the same for all cycles  $\rightarrow U$   
(synchronized image);

-  $n_i[k]$  - noise sample in cycle  $i$  for pixel  $k$  (noise power  $\sigma_n^2$ )

$$x_{disp}[k] = \frac{1}{M} \sum_{i=1}^M u_i[k] + \frac{1}{M} \sum_{i=1}^M n_i[k] = U + \frac{1}{M} \sum_{i=1}^M n_i[k]$$

- output noise power (white noise, uncorrelated with input signal)

$$\sigma_{n\_disp}^2 = E \left\{ \left( \frac{1}{M} \sum_{i=1}^M n_i[k] \right)^2 \right\} = \frac{1}{M^2} \sum_{i,j=1}^M E(n_i[k]n_j[k]) \Rightarrow \begin{cases} \sigma_{n\_disp}^2 = \frac{1}{M^2} \sum_{i=1}^M \sigma_n^2 = \frac{1}{M} \sigma_n^2 \\ \frac{SNR_{disp}}{SNR} = \frac{U^2}{\sigma_{no}^2} \cdot \frac{\sigma_n^2}{U^2} = M \end{cases}$$



## EIM Chap 3 – Digital oscilloscope

- Mobile window average of length  $M$

- $M$  acquisition cycles
- Needs high memory
- Introduces low delay (except for the first cycle)

(memorizing new sample → removing the oldest sample)

$$x_{disp}^{(i)}[k] = \frac{1}{M} \sum_{l=1}^{M-1} x_{i-l}[k] = x_{disp}^{(i-1)}[k] + \frac{x_i[k]}{M} - \frac{x_{i-M}[k]}{M}$$

**Samples in memory**

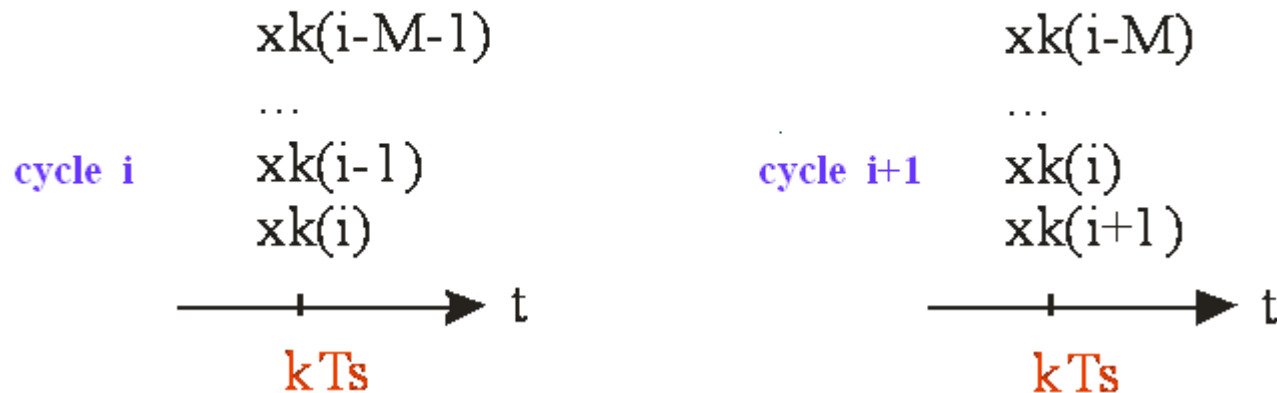

## EIM Chap 3 – Digital oscilloscope

- Continuous average
  - Needs low memory
  - Introduces low delay (has greatest latency for varying signal)

$$x_{disp}^{(i)}[k] = \frac{i-1}{i} x_{disp}^{(i-1)}[k] + \frac{1}{i} x_i[k] \quad \text{for } i < M$$

$$x_{disp}^{(i)}[k] = \frac{M-1}{M} x_{disp}^{(i-1)}[k] + \frac{1}{M} x_i[k] \quad \text{for } i \geq M$$

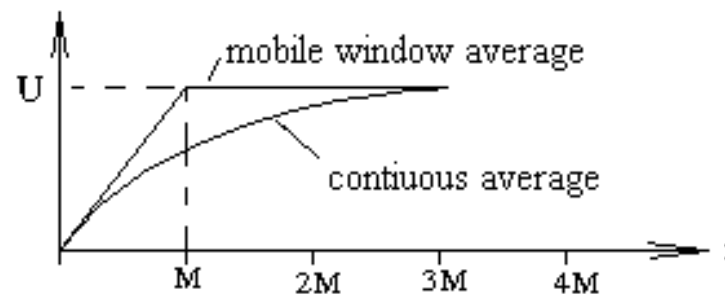

## EIM Chap 3 – Digital oscilloscope

### ■ Average effect – frequency domain

Exp: for  $M = 256$  cycles

$$\begin{aligned} SNR_{disp} &= SNR + 10 \cdot \log(M) \text{ [dB]} \\ &= SNR + 24 \text{ [dB]} \end{aligned}$$

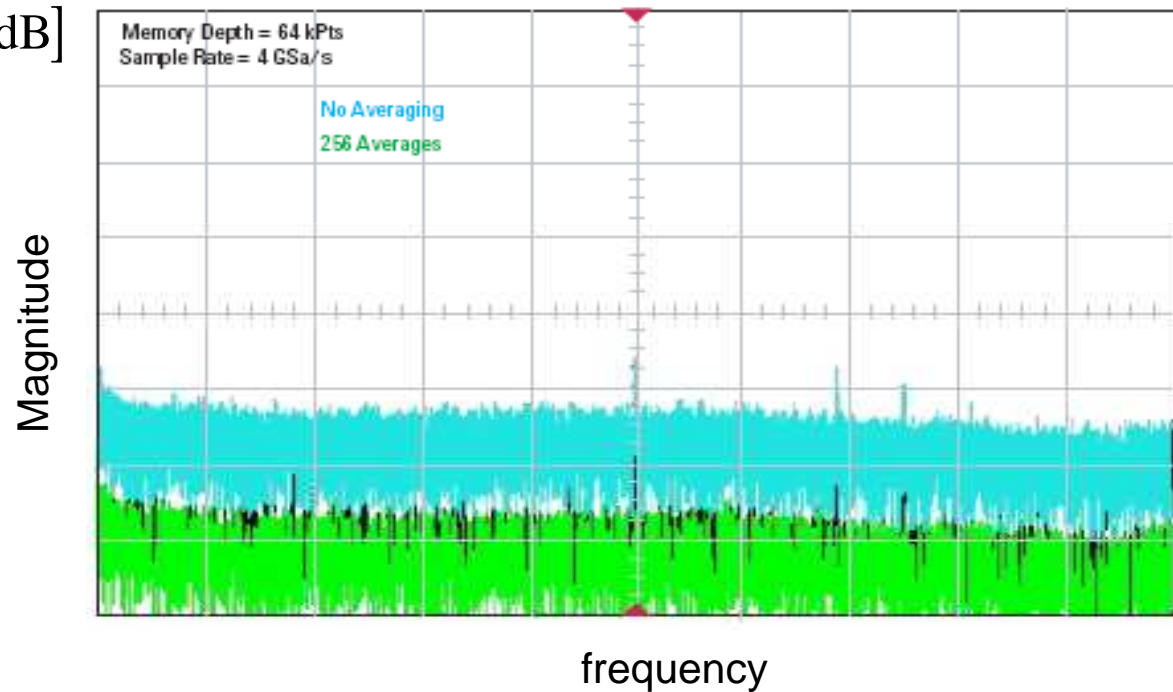

- Time base
  - For analog scope: commanded linear varying voltage generator, (saw-tooth waveform), recycling circuit, OX amplifier, etc;
  - For digital scope: digital counter that generate the memory addresses of displayed samples → the pixels index on the display;
  - Types:
    - Main time base – for normal wave display;
    - Delayed time base – user controlled delay between display and Sincro time. It operates as controlled zoom function in time domain for postrigger acquired data.

- **Microprocessor operation:**
  - Command for user and data interfaces
  - Digital signal processing to improve image quality
  - Signal parameters computing (maximum, minimum, mean, RMS values, signal frequency and period, etc)
  - FFT processing (frequency domain display)
  - Cursors positioning and value displaying
  - Math operation with waveforms (Math menu)
  - Improving SNR by digital filtering for low frequency signal

## EIM Chap 3 – Digital oscilloscope

- Example: FFT display for Tektronix TDS100
  - FFT computation → transforms the center 2048 points in time-domain waveform into 1024 FFT point spectrum;
  - FFT display: from DC (0Hz) to  $f_s/2$  (Nyquist frequency);
  - FFT display – 250 horizontal points (frequency bins);
  - Vertical display - signal harmonic components (rms values);

1. Frequency at the center graticule line
2. Vertical scale in dB per division (0 dB = 1 V<sub>RMS</sub>)
3. Horizontal scale in frequency per division
4. Sample rate in number of samples per second
5. FFT window type

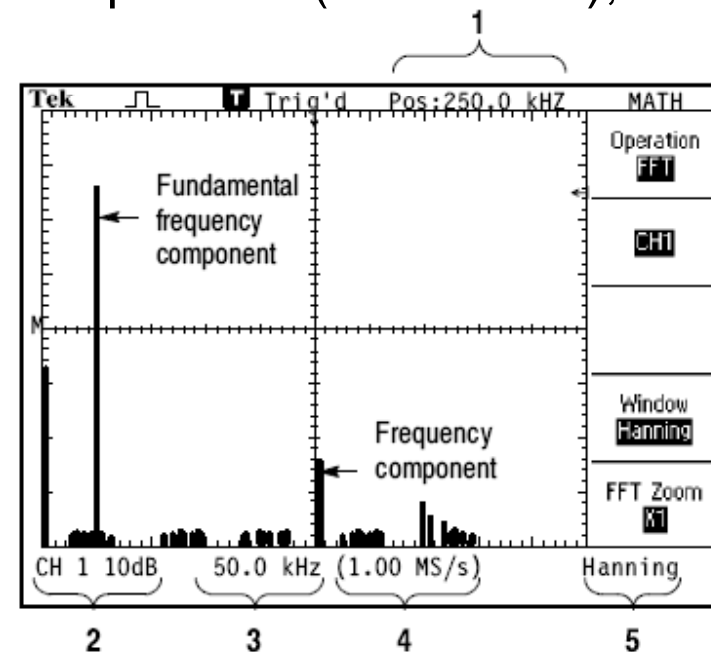

- Example: FFT display for Tektronix TDS100
  - FFT options:
    - Source (Ch1, Ch2 );
    - FFT zoom (x1, x2, x5, x10 );
    - Window
      - Hanning (better frequency, poor magnitude accuracy than flattop)
      - Flattop (better magnitude, poor frequency accuracy than Hanning)
      - Rectangular (for pulse and transient)

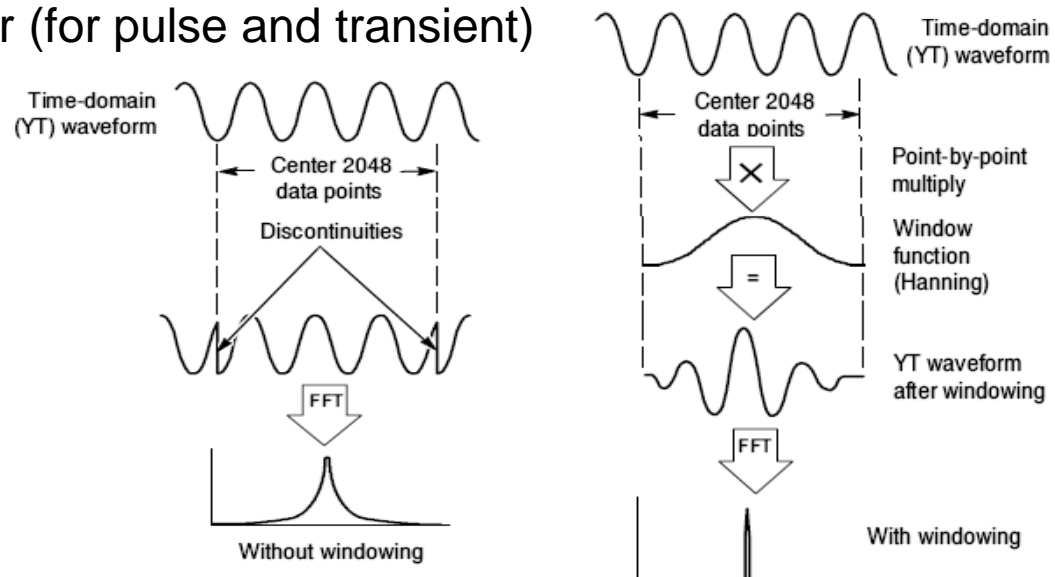

## **Advantage of Digital Scope**

- Trend towards digital.
- Easy to use.
- One-shot measurement
- Recoding (offline processing);
- Triggering (can display pre-triggering waveform);
- Data reuse
- Connectivity (connection interfaces with digital devices – PC ). Interfaces: USB, GPIB, RS232;



## Others - Probes

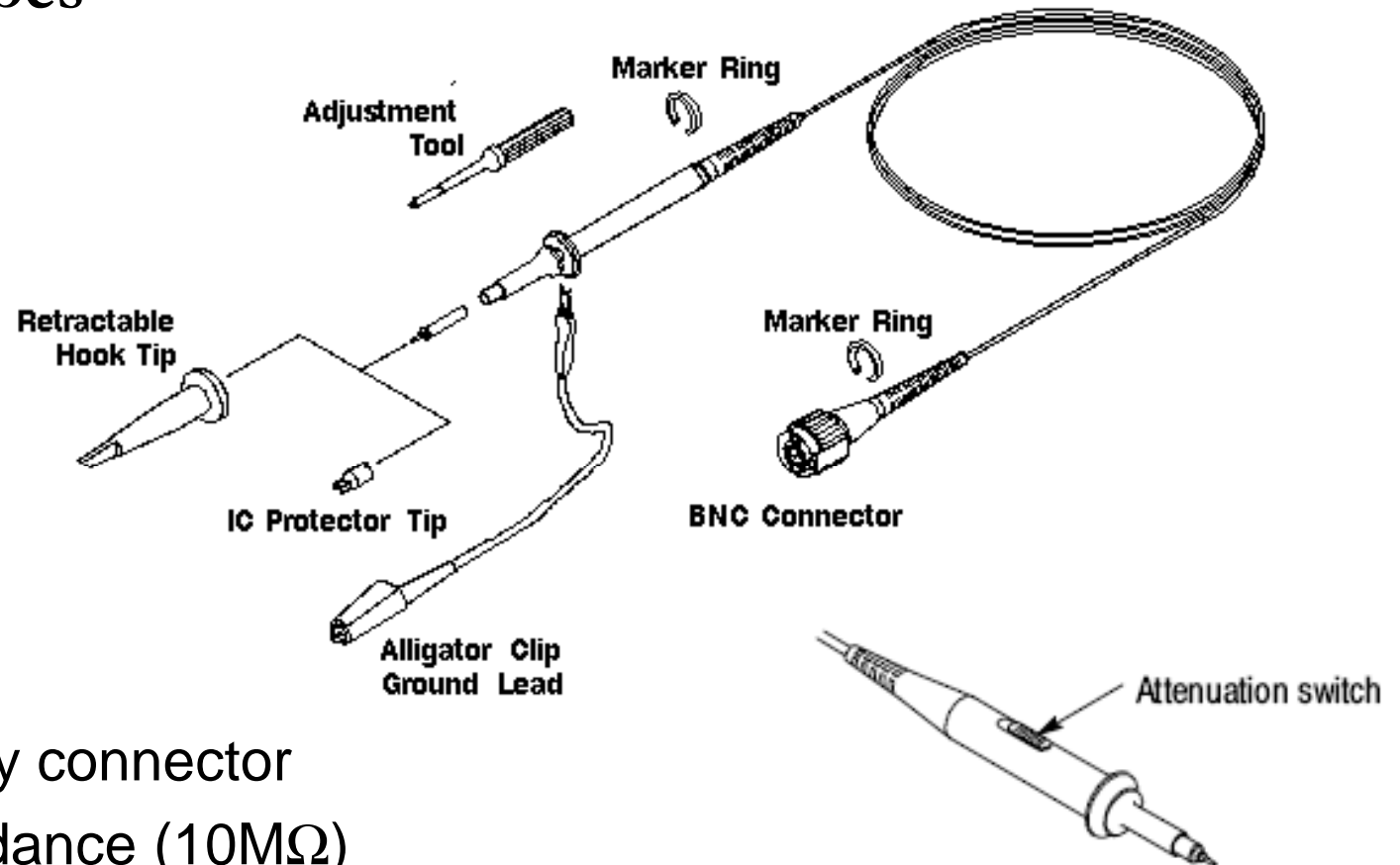

- High quality connector
- High impedance ( $10M\Omega$ )
- $50\Omega$  for high frequency measurement

## Probes types

- Passive probes
  - 10× attenuation
    - Good for low circuit loading
    - Suitable to high frequency signal
    - Difficult to measure less than 10mV signals
  - 1× attenuation
    - Good for small signals
    - Introducing more interference
- Active probes
  - Signal conditioning for oscilloscope
  - Require power source
  - Good for high speed digital signals over 100MHz clock frequency

■ **Bibliography**

- S. Ciochina, *Masurari electrice si electronice*, 1999 ;
- [ham.elcom.pub.ro/iem](http://ham.elcom.pub.ro/iem);
- *Application notes* - National Instruments;